

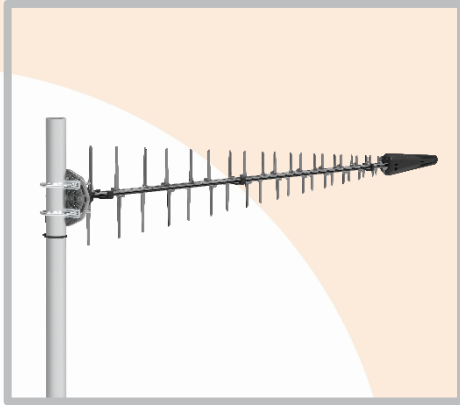











ANTENNAS | LPDA-500 SERIES

ULTRA-WIDEBAND, LOG-PERIODIC DIPOLE ARRAY 5G ANTENNA

617 – 7200 MHz, 11.5 dBi



 617 – 960 MHz 1427 – 1517 MHz 1710 – 2700 MHz 3400 – 4200 MHz 5000 – 7200 MHz	 11.5 dBi	 Increase X Mb/s	 Uni-Directional	 5G	 4G LTE
 BAND 71	 3.5 GHz CBRS	 Wi-Fi DUALBAND		 -40°C to +80°C	 Fire Resistant
617 – 698 MHz	CBRS Band	2.4 – 2.5 GHz 5.0 – 7.2 GHz	IP 65		



APPLICATION AREAS

- Futureproof ultra-wideband antenna from 617 – 7200 MHz
- Exceptional high gain performance over entire frequency range
- Compatible with 2G, 3G, 4G and future 5G technologies
- Improves mobile network subscriber's user experience
- Ruggedized design for weather and vandal protection (IP65)
- Deployable in any extreme weather conditions

Product Overview

The LPDA-500 is Poynting's new and improved log-periodic dipole array (LPDA) antenna. The LPDA-500 is a high-gain, ultra-wideband, uni-directional antenna that operate from 617 to 7200 MHz. The ultra-wideband coverage includes current 5G and future cellular bands as well as Wi-Fi and Wi-Fi 6E bands. The LPDA-500 has consistent high-gain performance across the entire band of operation, making the antenna suitable for the deployment of various wireless communication systems. Our previous LPDA has been successfully used in extreme weather environments across the world with close to zero failures, with the new LPDA-500 being no different.

The LPDA-500 comes standard with a new and improved mounting bracket, which can be rotated at 45° intervals. This will allow for ease of installation and the customer will be able to mount multiple LPDA-500 antennas and orientate them in a MIMO configuration, i.e., vertical, and horizontal or ±45°. Poynting Antennas are well known for designing future proof antennas and the new LPDA-500 is no different.

Features

- Exceptional high gain, uni-directional antenna
- Ultra-wideband coverage from 617 to 7200 MHz
- Wall or pole mountable for ease of installation
- Weatherproof and waterproof design (IP65)
- Lightweight and rugged design

Application Areas

- Outdoor antenna for Fixed Wireless Access (FWA)
- Consumer LTE/5G internet connectivity
- Industrial & Commercial LTE/5G and Wi-Fi deployments
- Urban & Rural household reception enhancement
- Agricultural & farming LTE/5G & Wi-Fi data distribution
- Oil & Gas communication systems
- Repeaters & coverage enhancement amplifiers



Frequency Band

The LPDA-500 is a directional antenna that works from 617 – 960 MHz | 1427 – 1517 MHz | 1710 – 2700 MHz | 3400 – 4200 MHz | 5000 – 6000 MHz | and the following Wi-Fi frequency bands | 2400 – 2500 MHz | and | 5000 – 7200 MHz |

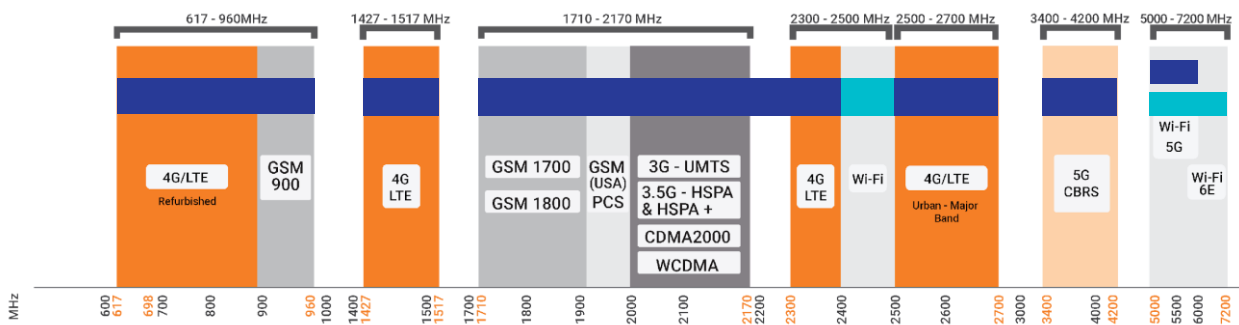

Indicates the LTE bands on which LPDA-500 works Indicates the WI-FI bands on which LPDA-500 works

Antenna Overview

	
Ports	1
SISO / MIMO	SISO
Frequency Bands	617 – 7200 MHz
Polarisation	Vertical (Linear)
Peak Gain	11.5 dBi
Coax Cable Type	N/A
Coax Cable Length	N/A
Connector Type	N-Type (F)

**The coax cable & connector are factory mounted to the antenna*

Electrical Specifications

Frequency bands:	617 – 960 MHz 1427 -1517 MHz 1710 -2700 MHz 3400 – 4200 MHz 5000 – 6000 MHz 6000 -7200 MHz
Gain (Max):	10.5 dBi @ 617 – 960 MHz 10 dBi @ 1427 -1517 MHz 11 dBi @ 1710 -2700 MHz 11.5 dBi @ 3400 – 4200 MHz 10 dBi @ 5000 – 6000 MHz 9 dBi @ 6000 -7200 MHz
VSWR:	<2:1
Feed power handling:	10 W
Input impedance:	50 Ohm (nominal)
Polarisation:	Linear Vertical
DC short:	Yes

Product Box Contents

Antenna:	A-LPDA-0500-V1-01
Mounting bracket:	Econo bracket, U-bolt and fasteners suitable for pole mounting

Ordering Information

Commercial name:	LPDA-500
Order product code:	A-LPDA-0500-V1-01
EAN number:	6009710925447

Mechanical Specifications

Product dimensions	1385 mm x 250 mm x 145 mm
Packaged dimensions:	1430 mm x 280 mm x 160 mm
Weight:	1.52 Kg
Packaged weight:	3.34 Kg
Frame material:	Passivated ADC 12
Frame colour:	Aluminium grey
Mounting Type:	Pole mount

Environmental Specifications, Certification & Approvals

Wind Survival:	≤160 km/h
Temperature Range (Operating):	-40°C to +80°C
Environmental Conditions:	Outdoor/Indoor
Water ingress protection ratio/standard:	IP 65
Salt Spray:	MIL-STD 810G/ASTM B117
Operating Relative Humidity:	Up to 98%
Storage Humidity:	5% to 95% - non-condensing
Storage Temperature:	-40°C to +80°C
Enclosure Flammability Rating:	UL 94-HB
Impact resistance:	IK 08
Product Safety & Environmental:	Complies with CE and RoHS standards



Antenna Performance Plots

VSWR

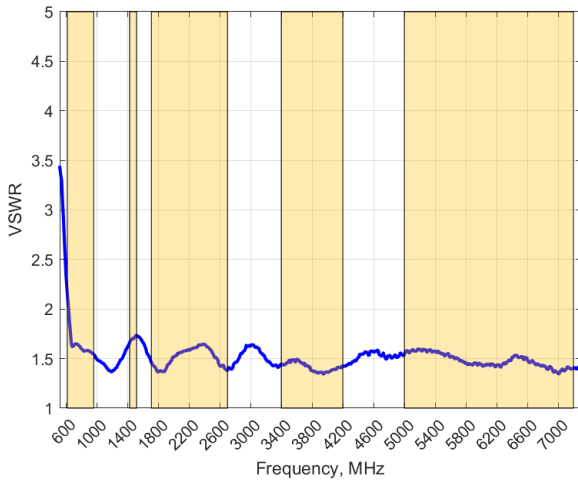

GAIN (EXCLUDING CABLE LOSS)

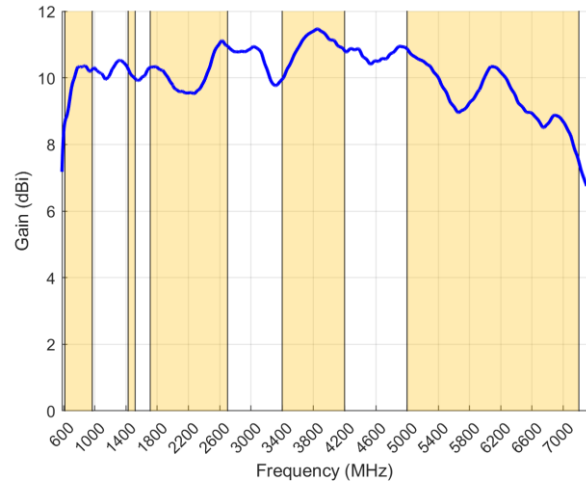

Voltage Standing Wave Ratio (VSWR)*

VSWR is a measure of how efficiently radio-frequency power is transmitted from a power source, through a transmission line, into a load. In an ideal system, 100% of the energy is transmitted which corresponds to a VSWR of 1:1.

The LPDA-500 delivers superior performance across all bands with a VSWR of <2:1.

Gain* in dBi

11.5 dBi is the peak gain across all bands from 617 – 7200 MHz

Gain @ 617 – 960 MHz:	10.5 dBi
Gain @ 1427 – 1517 MHz:	10 dBi
Gain @ 1710 – 2700 MHz:	11 dBi
Gain @ 3400 – 4200 MHz:	11.5 dBi
Gain @ 5000 – 6000 MHz:	10 dBi
Gain @ 6000 – 7200 MHz:	9 dBi

*VSWR measured with a 2m low loss cable.

*Antenna gain measured with polarisation aligned standard antenna

Technical Drawings

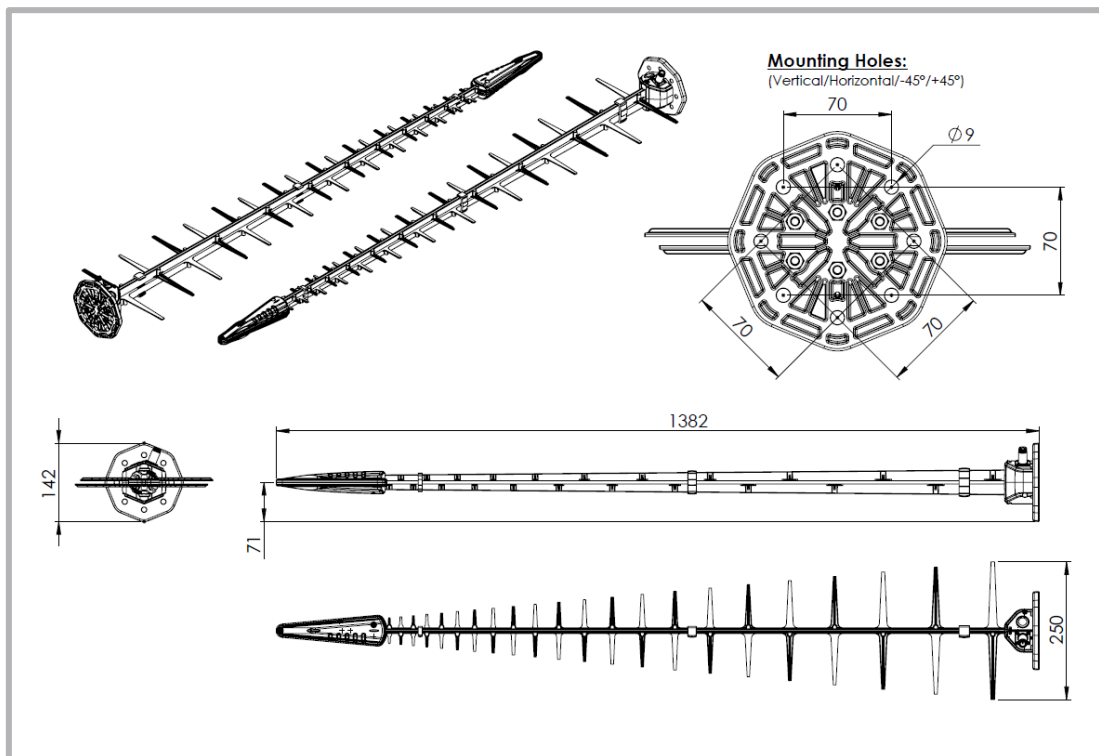

Radiation Patterns

Azimuth: 617 – 968 MHz

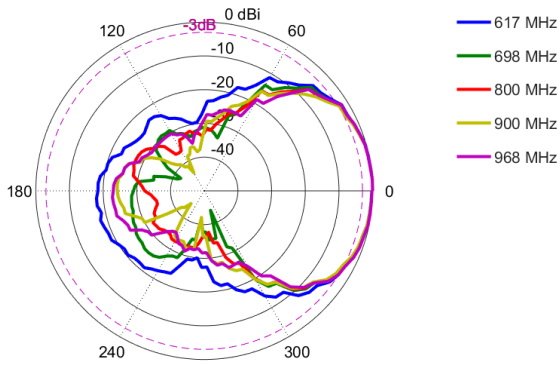

Azimuth: 1427 – 1517 MHz

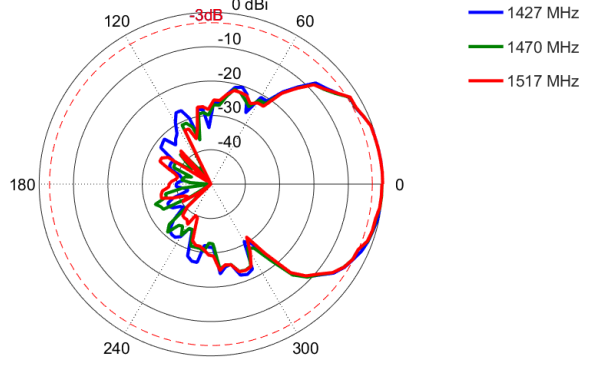

Azimuth: 1710 – 2100 MHz

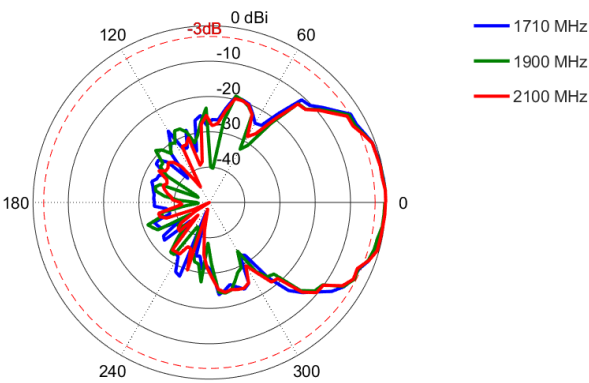

Azimuth: 2300 – 2700 MHz

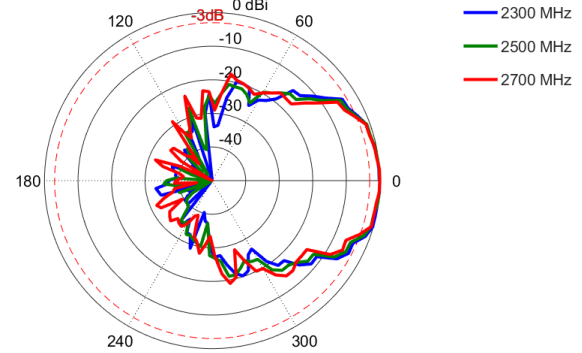

Azimuth: 3400 – 3700 MHz

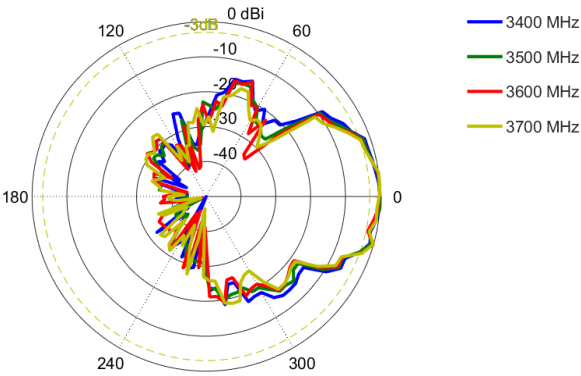

Azimuth: 3800 – 4200 MHz

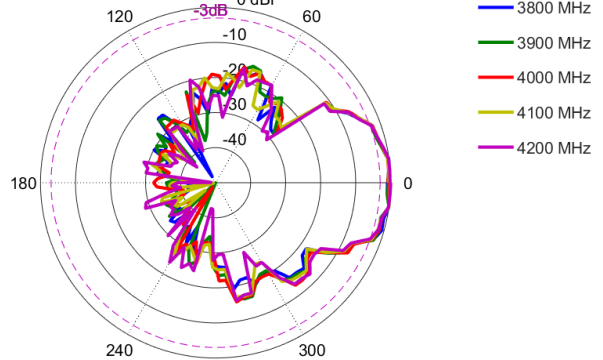

Azimuth: 5000 – 6000 MHz

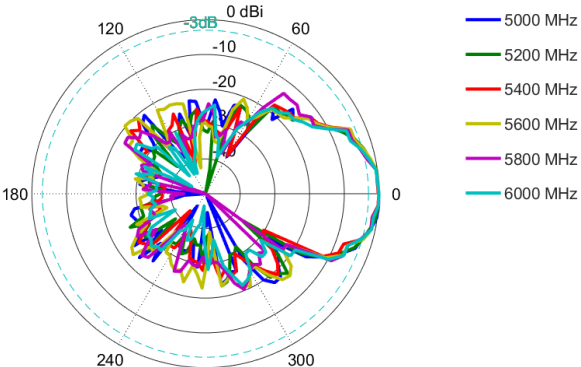

Azimuth: 6200 – 7200 MHz

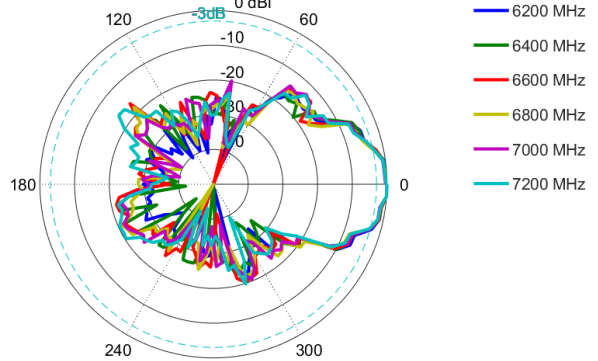

Elevation: 617 – 968 MHz

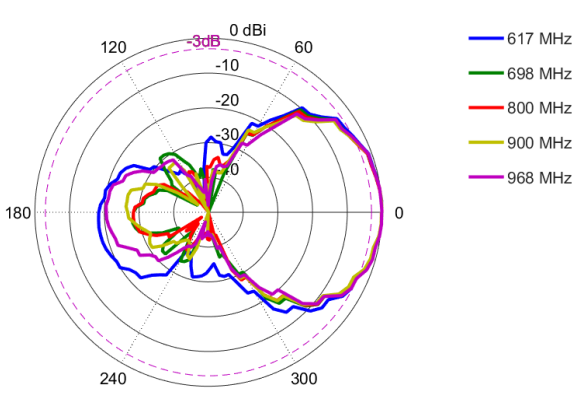

Elevation: 1427 – 1517 MHz

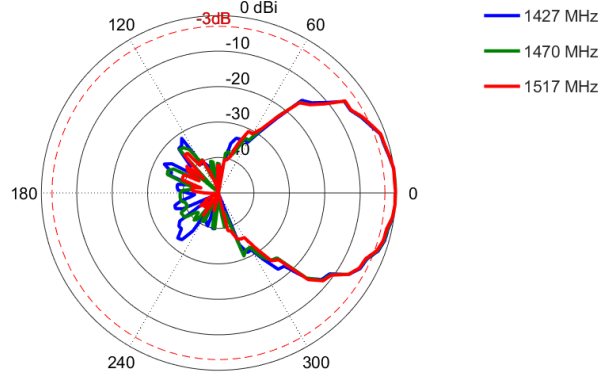

Elevation: 1710 – 2100 MHz

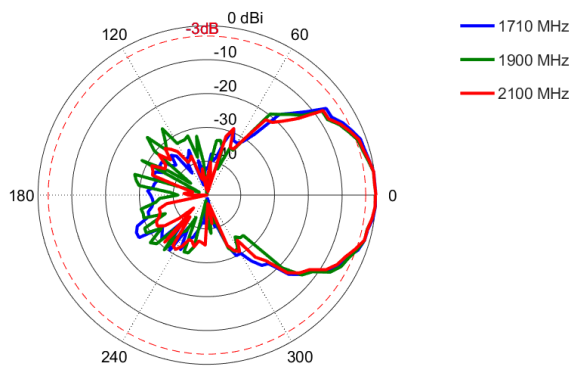

Elevation: 2300 – 2700 MHz

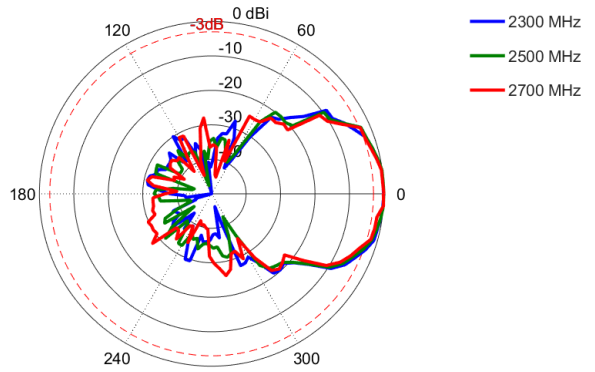

Elevation: 3400 – 3700 MHz

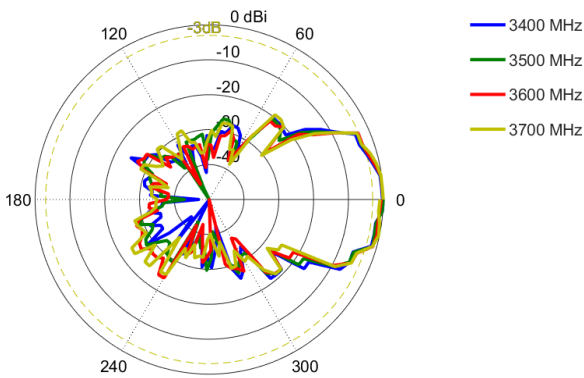

Elevation: 3800 – 4200 MHz

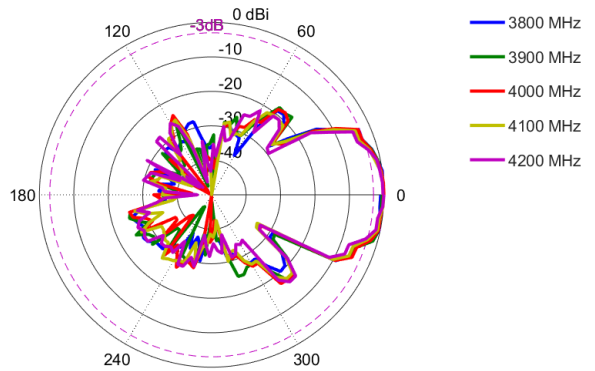

Elevation: 5000 – 6000 MHz

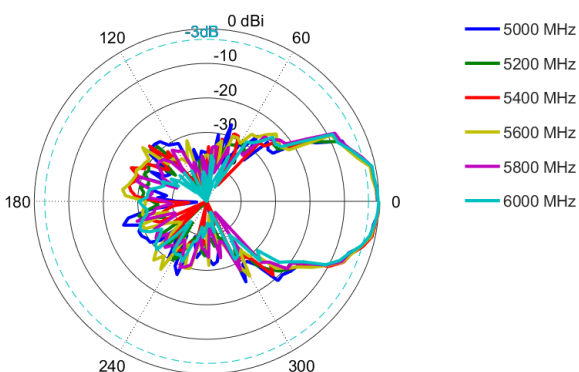

Elevation: 6200 – 7200 MHz

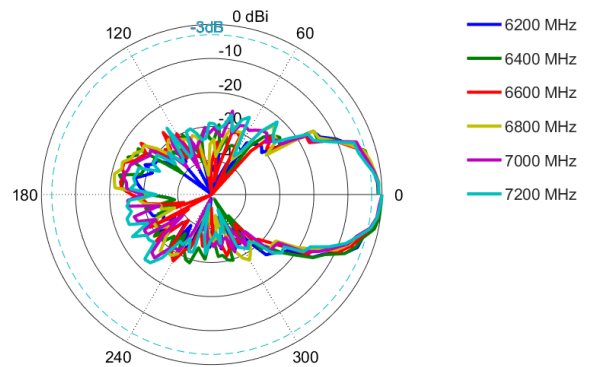

Mounting Options

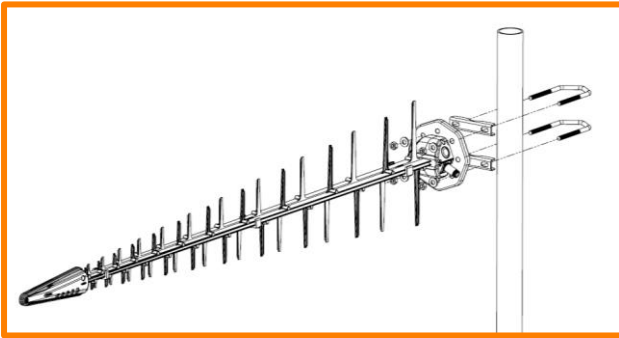

Pole Mount

Pole mounted with provided U-bolts

Additional Accessories

See accessories technical specifications on www.poynting.tech

CONTACT POYNTING

Poynting Antennas (Pty) Ltd - Head Office

Unit 4, N1 Industrial Park,
Landmarks Avenue,
Samrand, 0157, South Africa

Phone: +27 (0) 12 657 0050

E-mail: info@poynting.tech

International Email: sales-global@poynting.tech

Poynting Europe

Regus Business Center Neue Messe Riem
Kronstadter Straße 4
81677 München
Germany

Phone: +49 89 7453 9002

E-mail: sales-europe@poynting.tech

Poynting USA

1804 Owen Court, Suite 104,
Mansfield,
TX 76063
USA

Phone: +1 817 533-8130

E-mail: sales-us@poynting.tech