

## ANTENNAS | OMNI-404 SERIES

# OMNI-DIRECTIONAL MARINE AND COASTAL LTE/5G ANTENNA

698 - 3800 MHz; 2 dBi

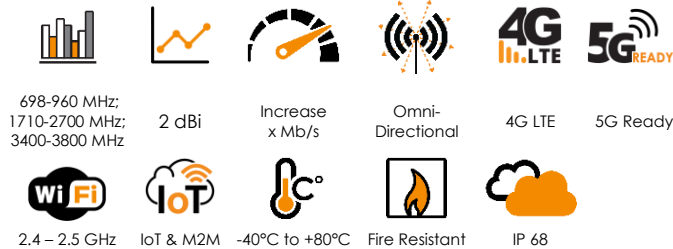

- **Marine quality, low profile, omni directional antenna**
- **Suitable for 5G deployments up to 3800 MHz**
- **Robust and all-weather proof for harsh conditions at sea**
- **Easy mounting with feed through a standard 1-inch marine adapter bracket which is included**
- **Various marine grade stainless steel mounting brackets available optionally**
- **UV and saltwater protected against tempestuous weather conditions**
- **Protected against water and dust ingress, IP68**



## Product Overview

The OMNI-404 is a wide band LTE/5G antenna with a smaller profile radome which is specifically designed for adverse marine & coastal environments. This antenna covers all contemporary LTE operating frequencies, from 698 to 3800 MHz, with excellently balanced gain across all frequencies, enhancing LTE performance features, such as multi carrier aggregation (CA). This antenna is also suitable on all 5G networks up to 3800 MHz. The antenna is designed for superior pattern control over the entire frequency range, making the OMNI-404 an exceptional omni-directional antenna for its size and application. Poynting Antennas achieves this through a new antenna design using multiple dipoles and a unique (patented) feed network. A standard 1-inch (14 TPI) marine mount connector is used for simplified installation to most standard marine attachments.

## Features

- Medium gain omni-directional antenna
- The antenna is purpose-built for marine and coastal applications
- Fits directly to standard 1-inch (14 TPI) marine mount
- UV and salt-water resistant
- Robust and weather resistant with IP68 rating

## Application Areas

- Marine applications / Yachts / Boats / Ferries
- Enhanced LTE Reception
- IoT and M2M
- Poor data signal reception
- Improve data transmission connection reliability & stability

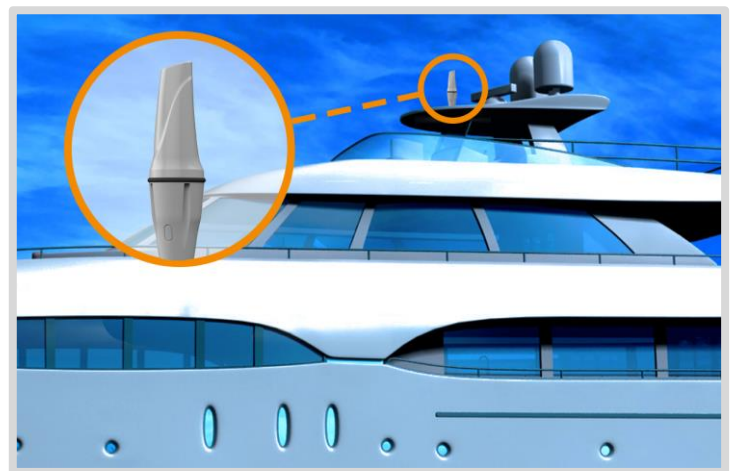

### Frequency bands

The OMNI-404 is a marine antenna that works from | 698-960 MHz | 1710-2700 MHz | 3400-3800 MHz

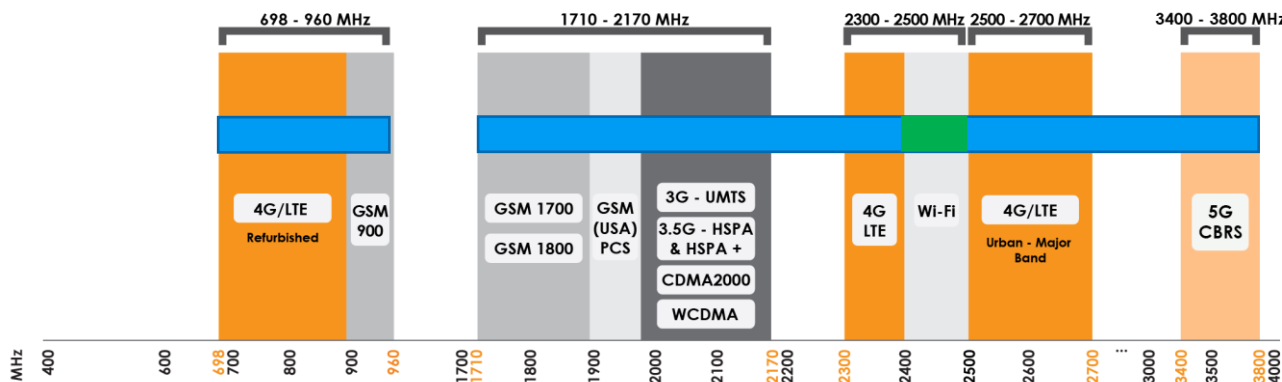

█ Indicates the LTE/5G bands on which OMNI-404 works     █ Indicates the WI-FI bands on which OMNI-404 works

### Antenna Overview

Ports	1
SISO / MIMO	SISO
Frequency Bands	698 – 3800 MHz
Peak Gain	2 dBi
Coax Cable Type	N/A
Coax Cable Length	N/A
Connector Type	N-Type (F)

*\*The connector is factory mounted to the antenna*

## Electrical Specifications

<b>Frequency bands:</b>	698-960 MHz 1710-2700 MHz 3400-3800 MHz
<b>Gain (max):</b>	-4 dBi @ 698-960 MHz 2 dBi @ 1710-2700 MHz 1.5 dBi @ 3400-3800 MHz
<b>VSWR:</b>	≤ 2.5:1
<b>Feed power handling:</b>	10 W
<b>Input impedance:</b>	50 Ohm (nominal)
<b>Polarisation:</b>	Linear Vertical
<b>DC short:</b>	Path to Ground

## Product Box Contents

<b>Antenna:</b>	A-OMNI-0404
<b>Mounting bracket:</b>	1" (14 TPI) Marine Adapter (BRKT-40)

## Ordering Information

<b>Commercial name:</b>	OMNI-404
<b>Order product code:</b>	A-OMNI-0404-V1-01
<b>EAN number:</b>	6009710920923

## Mechanical Specifications

<b>Product dimensions:</b>	252 mm x Ø75 mm (Incl. BRKT-40)
<b>Packaged dimensions:</b>	288 mm x 97 mm x 97 mm
<b>Weight:</b>	0.35 Kg
<b>Packaged weight:</b>	0.50 Kg
<b>Radome material:</b>	UV Stable Marine ASA
<b>Radome colour:</b>	Brilliant White Pantone P 179-1 C
<b>Mounting Type:</b>	Standard 1" -14 TPI marine mount

## Environmental Specifications, Certification & Approvals

<b>Wind Survival:</b>	<190 km/h
<b>Temperature Range (Operating):</b>	-40°C to +80°C
<b>Environmental Conditions:</b>	Outdoor/Indoor
<b>Water ingress protection ratio/standard:</b>	IP 68
<b>Salt Spray:</b>	MIL-STD 810F/ASTM B117
<b>Operating Relative Humidity:</b>	Up to 98%
<b>Storage Humidity:</b>	5% to 95% - non-condensing
<b>Storage Temperature:</b>	-40°C to +80°C
<b>Enclosure Flammability Rating:</b>	UL 94-HB
<b>Impact resistance:</b>	IK 10
<b>Product Safety &amp; Environmental:</b>	Complies with CE and RoHS Standards



**Antenna Performance Plots**

**VSWR**

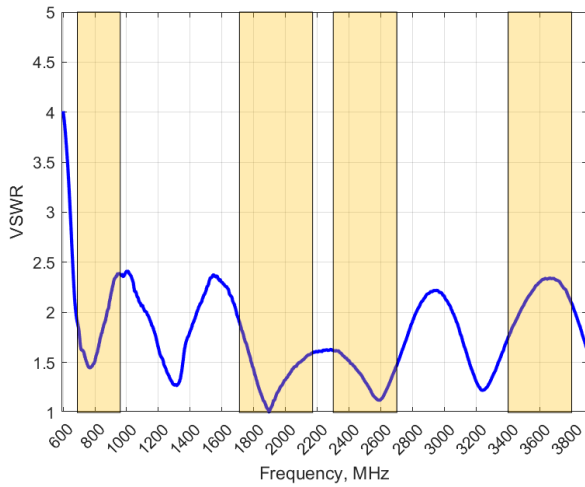

**GAIN: (excluding cable loss)**

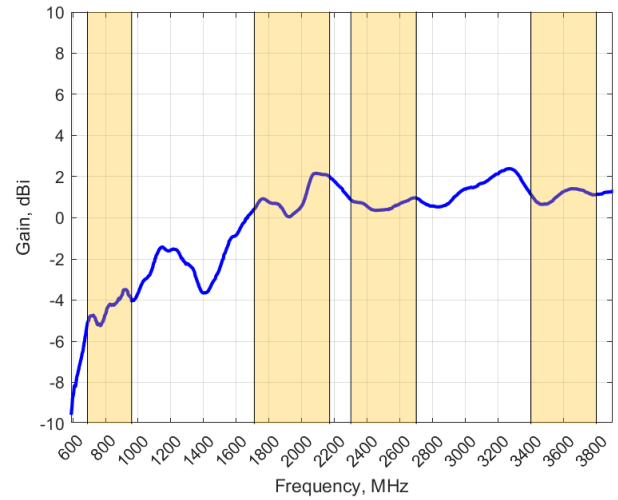

**Voltage Standing Wave Ratio (VSWR)\***

VSWR is a measure of how efficiently radio-frequency power is transmitted from a power source, through a transmission line, into a load. In an ideal system, 100% of the energy is transmitted which corresponds to a VSWR of 1:1

The OMNI-404 delivers superior performance across all bands with a VSWR of <2.5:1

\*Antenna VSWR measured with 2m low loss cable

**Gain\* in dBi**

2 dBi is the peak gain across all bands from 690 – 3800 MHz

Gain @ 698-960MHz	-4 dBi
Gain @ 1710-2700MHz	2 dBi
Gain @ 3400-3800MHz	1.5 dBi

\*Antenna gain measured with polarisation aligned standard antenna

**Technical Drawings**

With Standard Marine Mounting and BRKT-39 (not included)

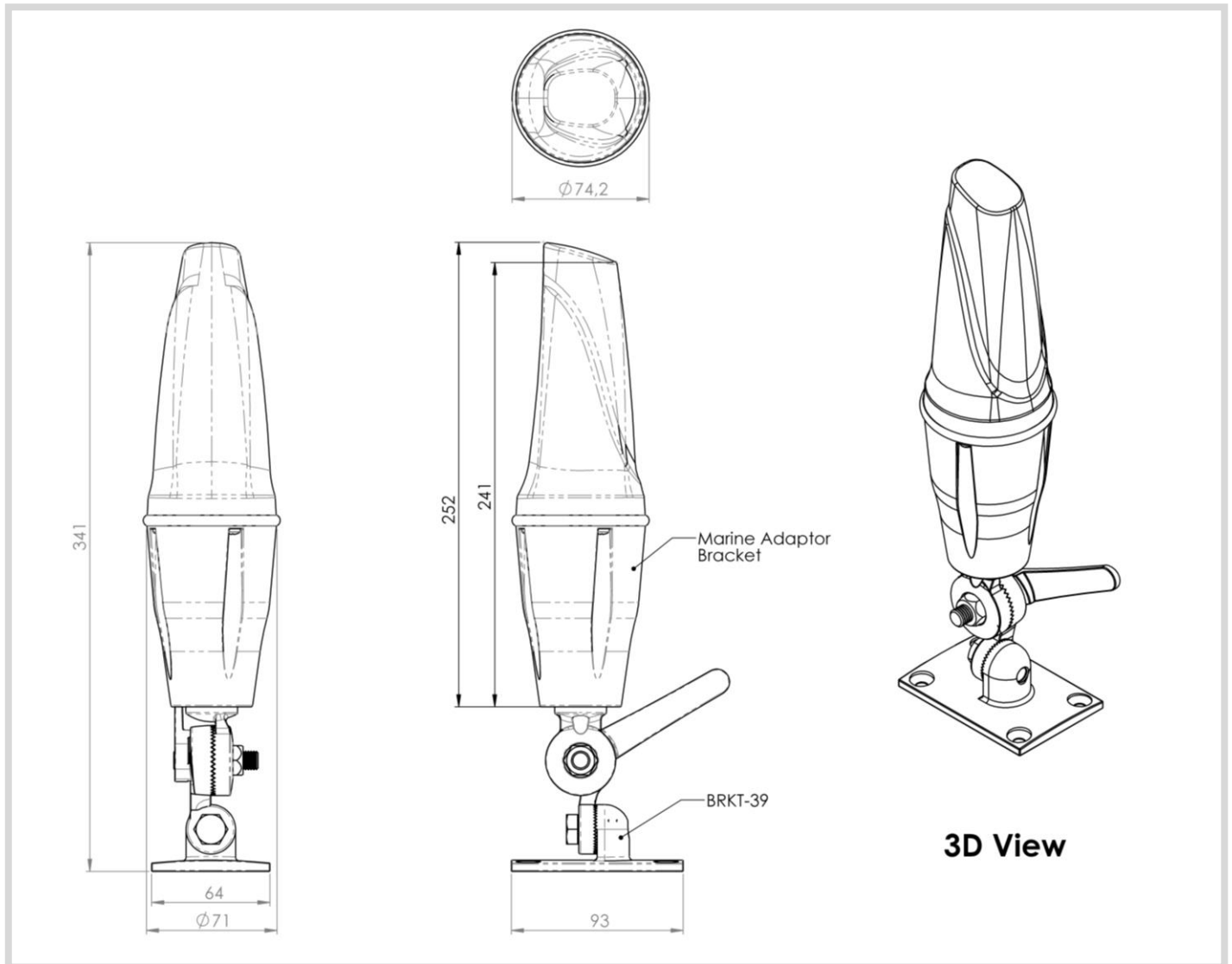

**Radiation Patterns**

Azimuth (Top View): 690–960 MHz

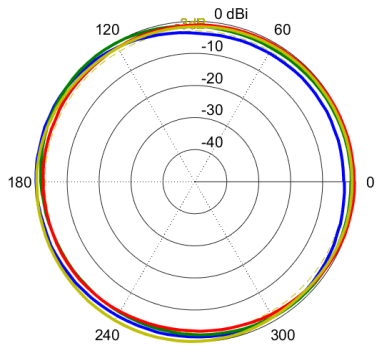

Azimuth (Top View): 1710–2170 MHz

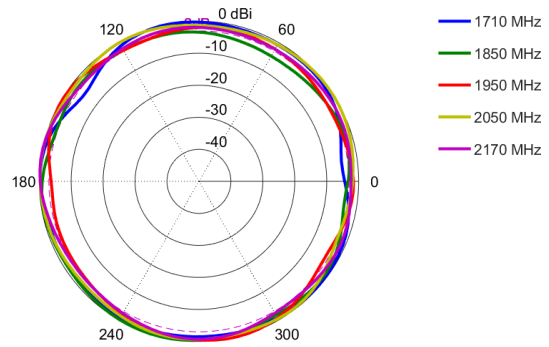

Azimuth (Top View): 2170–2700 MHz

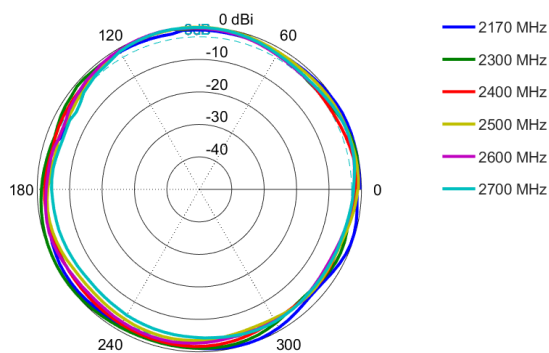

Azimuth (Top View): 3400–3800 MHz

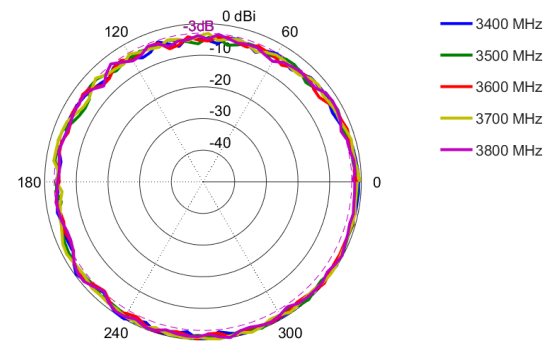

Elevation1 (Side View): 690–960 MHz

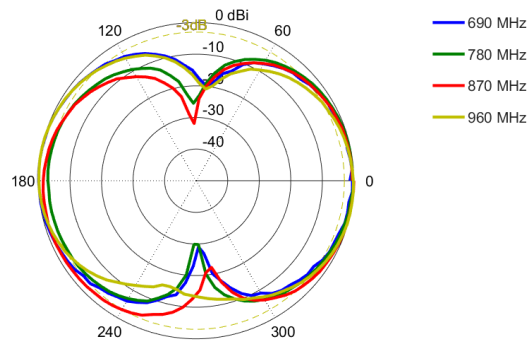

Elevation1 (Side View): 1710–2170 MHz

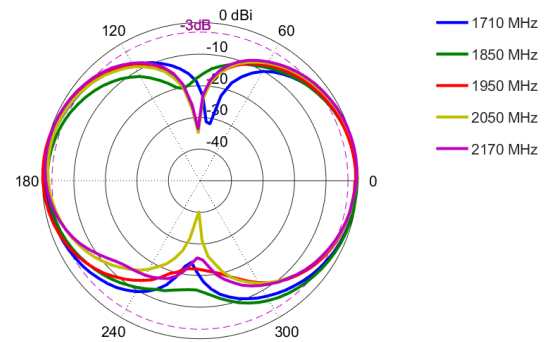

Elevation1 (Side View): 2170–2700 MHz

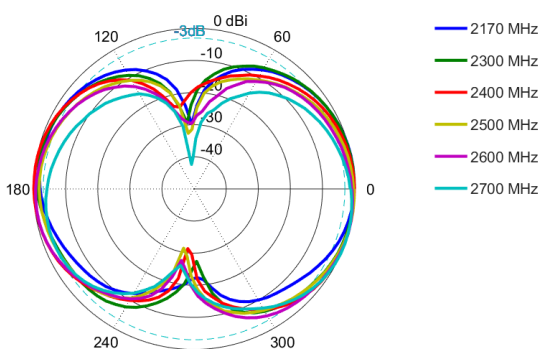

Elevation1 (Side View): 3400–3800 MHz

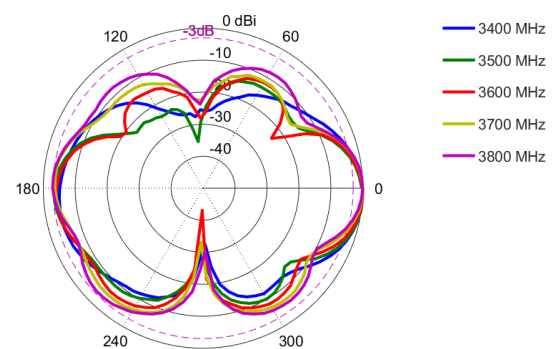

## Mounting Options

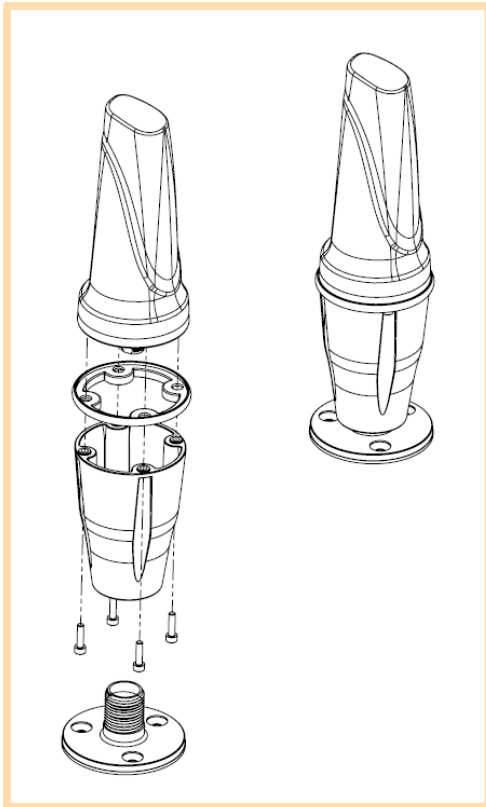

### Marine Bracket Mount

1" -14 TPI female adapter – included

Mounts to standard marine brackets:

- BRKT-37: Flat Mount - Optional
- BRKT-38: Ratchet Mount - Optional
- BRKT-39: Rail Mount - Optional

See Optional Accessories below

Also available: BRKT-41 with 1.25" – 11 TPI female adapter (Optional)

---

## Optional Accessories



### BRKT-37

Marine flat mount antenna bracket 1"-14TPI 316 Stainless Steel

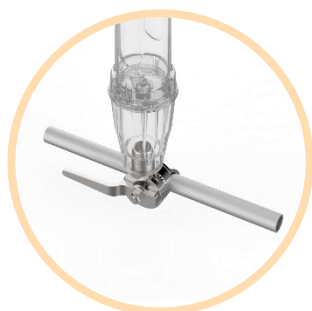

### BRKT-38

Marine ratchet rail mount antenna bracket 1"-14TPI 316 Stainless Steel



### BRKT-39

Heavy duty marine mount antenna bracket 1"-14TPI 316 Stainless Steel

See accessories technical specifications on [www.poynting.tech](http://www.poynting.tech)

---

## Contact Poynting

### Poynting Antennas (Pty) Ltd - Head Office

Unit 4, N1 Industrial Park  
Landmarks Avenue,  
Samrand, 0157  
South Africa

**Phone:** +27 (0) 12 657 0050

**E-mail:** [sales@poynting.co.za](mailto:sales@poynting.co.za)

### Poynting Europe

Regus Business Center Neue Messe Riem  
Kronstadter Straße 4  
81677 München  
Germany

**Phone:** +49 89 208026538

**E-mail:** [sales-europe@poynting.tech](mailto:sales-europe@poynting.tech)